

# WAKANA

Washington Kitefliers Association

WKA NEWSLETTER  
FEBRUARY/MARCH  
1989

## MANLIFTING THE ULTIMATE IN KITE EXCITEMENT

by DAN SCHWENK

The Schwenk Brothers, Dan & Dixon, met Kelly Kirschenman for the first time at Fort Casey, Washington in July of 1988. They had assembled with other kitefliers for a day of kites and fun at a kite festival sponsored by the Bellingham based Squaticum Kitefliers. The three had no idea of the excitement that would be generated that day. Before the sun had set, the surprised and fascinated folks at Fort Casey would see Jeremy Schwenk, Dixon's sixteen year old son, tethered to an observation tower and soaring more than twenty feet in the air under the power of twelve



North American Powerkite Manlift Team flyer Jeremy Schwenk flying a stack of Flexifoil kites 20' off the ground at the WSIKF at Long Beach

### IN THIS ISSUE

#### FORT WORDEN KITE MAKER'S CONFERENCE

— See the Insert

WKA ADVERTISERS 11

— Help Them Help Us!

CLASSIFIED ADS 11

FROM THE EDITOR'S DESK 11

KITE CALENDAR 16

MORE HOT AIR (LETTERS) 12

#### OFFICIAL BUSINESS

— Officer's Reports 6

— Last Minutes 7

— Regional Reports 10

— Welcome New Members 10

SALMAGUNDI, POTPOURRI, 8

ETC.

THE SINGLES LINE 11

— Van Gilder's T.L.A.R. Delta

Flexifoil kites. In different parts of the State of Washington and unknown to each other, Kirschenman and the Schwenks had been developing their separate ideas how to use Flexifoil kites to lift a man safely into the air and return him gently to the ground again. This chance meeting at Fort Casey brought together more than nine years of combined effort and experience. Amazingly the two technologies were made for each other. Weak points and questions asked by one were answered by the other. Dixon, Dan, and Kelly had unknowingly formed the core of what would later become the North American Powerkite Manlift Team.

The Washington State International Kite Festival at Long Beach was the natural place for the NAPMT to make its manlift debut. Jeremy Schwenk took center stage once again as the most adept and skilled flyer on the team. Other team members took their turns entertaining hundreds of spectators, but, most importantly, the team was able to further test the contraption they had created.

In the weeks following Long Beach and prior to the kite festival in Lincoln City, Oregon,

Kirschenman and the Schwenks, along with their respective mates, had numerous conferences. Safety issues became the recurring topics of discussion. Expenditures related to safety modifications and upgrading of equipment exceeded \$4000 at this point. The team unanimously agreed that along with a focus on their own safety, it was important to convey their concern for safety to the public. The team believes that demonstrating a healthy and abiding attitude toward safety is the best example they can make for other kites.

"Where do they go from here?" you might ask. Nobody on the team seems to be completely sure. Kelly Kirschenman would opt for worldwide manlift demonstrations starting next week; Dixon Schwenk would settle for U.S. domination by next summer; while Dan Schwenk, the team "jokester", would be content with any site providing a three hundred foot circle of safety tape and a P.A. system for him to emcee and deliver his latest one-liners. There is one thing about the future they all agree on — the sky is the limit!

*for additional information contact the North American Powerkite Manlift Team, P.O. Box 5713, Bellevue, WA 98008*

## 15th ANNUAL NEW YEAR'S DAY "PROTEST THE BOWLS" KITEFLY

by JACK VAN GILDER and DAVID JULIAN

In terms of attendance, quality, quantity, and variety, or any other standards, this was one of the most successful NYDPTB kiteflies ever. We had

excellent media coverage with pictures in both the Seattle Times and the Seattle Post-Intelligencer and stories on the late night news on TV

### WKA NEWSLETTER February 1989 Vol. 1989 No. 1

The WKA NEWSLETTER is published bimonthly (even numbered months) by the Washington Kitefliers Association, Pacific Science Center, 200 Second Avenue North, Seattle, WA 98109. Mail subscriptions are free to WKA members.

Editor: DAVID JULIAN (206) 453-8895

Contributing Editor: JACK VAN GILDER (206) 938-0550

The WKA NEWSLETTER welcomes any and all contributions pertaining to kite flying. Submit typewritten manuscripts and standard black and white or color print photos (include the name, address, and daytime phone number of the source) along with a stamped, self-addressed envelope of sufficient size and postage for return to David Julian, WKA NEWSLETTER Editor, 10254 NE 21st Place, Bellevue, WA 98004. The deadline for all submissions is the 15th of the month prior to issue. All submissions will be considered for publication.

Washington Kitefliers Association is a non-profit organization dedicated to helping people discover all the joys of kite flying. To become a WKA member, send your name, address, and telephone number, along with a check for \$10 (outside U.S. please add \$2 for additional postage) to Washington Kitefliers Association, Pacific Science Center, 200 Second Avenue North, Seattle, WA 98109. Membership will include an official WKA membership card entitling the bearer to discounts at certain kite shops and a one year free mail subscription to the WKA NEWSLETTER.

### 1989 WKA OFFICERS

President: Darryl Stephison (206) 657-7334  
Vice Pres: Stan Swanson (206) 782-1472

Treas. pro tem: Bob Hanna (206) 767-6381  
Secretary: Jody Hagaman (206) 789-9215

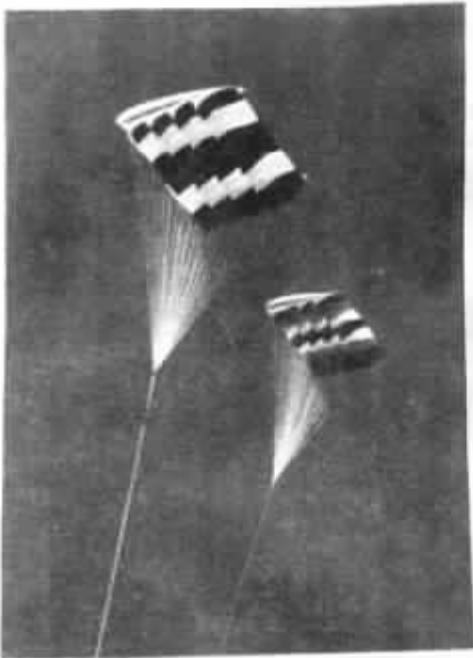

Clockwise: Haganam Parafoils flown by Doug & Jody Haganam down on the beach; the rented shelter tent, a welcome addition this year and the site of the gourmet picnic provided by Dorothea Checkley; Stan Swanson flies his Elephant Kite prototype right in front of tailgate party goers; Doug & Lynn Garza from City Kites; Ken Conrad's 300 Mini-Eddy train looks like mere thread next to Van Gilder's 84 Deltas;



**Kitefliers Nightmare:** Expert kites Duane Davis, David Checkley (Jr.), David Morse, and David Julian assist in the rescue of Duane's Star kite from the clutches of the proverbial kite eating tree



channels 5 and 11.

This year's event was dedicated to the memory of David Checkley, founder of the event. Dorothea Checkley provided a buffet lunch of "picnic spaghetti", ham, and brownies, served in a shelter tent rented by WKA for that purpose.

There were well over a hundred WKAers and almost as many kites. It was overcast and cold but the breeze was offshore and a perfect 7 to 10 knots. Doug Garza of City Kites had a couple of man-shaped windsocks hanging from his parafoil kite string. WKA VP Stan Swanson debuted his new elephant kite prototype that he plans to begin manufacturing soon. WKA Past President Tom Sisson had his flexible flyer up, along with his parafoil that suspended the new official WKA Banner. Ken Conrad of Great Winds Kites had his 300-eddy kite train up, and Jack Van Gilder flew his 85-delta train at a near perfect angle. J.C. Young had one of his most spectacular centipede kites up. Doug Hagaman had a couple of his world famous parafoils up on the beach. On the ground level, Sari Moore displayed some of her Alaska Indian patches and WKA Secretary Jody Hagaman sold some of her hand-knitted headbands.

It was a great day of fellowship, tailgate party-goers, and renewing of old friendships.



## KTA TRADE SHOW — San Diego CA — January 12-14

by JACK VAN GILDER

This was the first convention of the Kite Trade Association since separating from the American Kitefliers Association conventions, and to all appearances it was a huge success. Washington was well represented by the Seattle shops, Kathy Goodwind of Suspended Elevations, Ken Conrad and Suzanne Sadow of Great Winds, Mike and Diane Aurigemma of City Kites, along with manufacturers Stan Swanson and Harry Osborne. Rod Yarger and Roy Willson of Yakima and Jerry Sinotte and Jim Busing of Long Beach also at-



Joel Scholz discusses his bee kite with Jerry Sinotte



Counterclockwise: Rod Yarger & Roy Willson with Jerry Sinotte; Diane Aurigemma from City Kites; Ken Conrad & Suzanne Sadow from Great Winds with a customer; Kathy Goodwind & Shelley Sherrard from Gasworks Kite Shop with Cory Jensen; Jack Van Gilder & Bill Johnson with Corey Jensen, Erik Forsberg with a special order kite from China; Harry Osborne

tended. There were many new designs and variations of traditional kites and accessories, but the hit of the show was a new four-line stunt kite called Revolution I that was designed by Joe & Jim Hadzicki of Neos Omega™ Kites of San Diego. Their video presentation was mind bog-

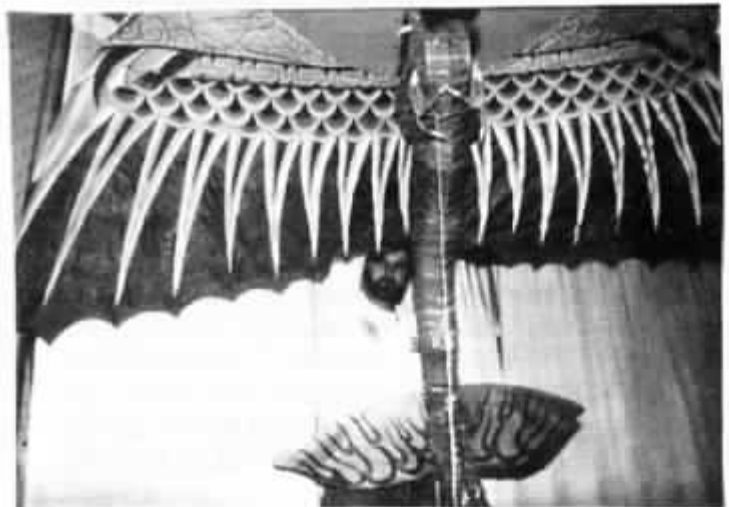

gling — the kite will fly forward, backward, and even sideways! Some more information about this extraordinary kite, excerpted by permission from a copyrighted handout by the designers:

By combining the technology of advanced composites and the stability theory of super agile fighter aircraft, the REVOLUTION I™ embodies the most advanced kite flying system available. Through the use of 100% graphite structure, semimonocoque design, and aerodynamically controlled wing surfaces, the REVOLUTION I™ Pro Series is designed to be neutrally stable in both static and dynamic flight modes. ...presently inaccessible to manned aircraft, this stability condition produces the hypercontrollability characteristic of the REVOLUTION I™. Luckily, mother nature throws in a little aerodynamic drag and momentum effects which reduce [these conditions] to a more manageable controlled flight.

As explained in the Owner's Manual, the unparalleled performance of the REVOLUTION I™ is attained by simply rotating the wrists in a fore and aft direction. Four basic combinations of the left and right wrist rotations produce ... the agility and pinpoint accuracy... Total speed control, instantaneous stopping, reverse flight, and propeller-like spins are only a few of the maneuvers possible...

The kite works on the principle of wing-warp-



Charles Singleton and his Revolution I™

ing, ironically one of the first principles used by the Wright Brothers. What this accomplishes is to keep the center of its turning radius in the middle of the kite, rather than at its wingtip or beyond. Its \$270 price tag is pretty revolutionary for a new product entry, but the high quality of materials, workmanship, and engineering make it well worth it.

---

## MUSEUM OF FLIGHT KITE EXHIBITION — January 21-22

by JACK VAN GILDER

Chairman Tom Sisson reported that over 800 Boka Boka kites were made kids (and some adults) at the exhibition, including 300 made on Super Bowl Sunday. Tom wanted to thank each of the 30 volunteers, especially August and Shasta Swanson, who brought their two girls over from Bainbridge Island and spent almost all day Saturday; Larry Chinn, who demonstrated his painting art on Chinese kites; J. C. Young, who hung his new 220 panel centipede kite, stretching it from one end of the exhibition hall to the other, and

then stayed around for the two days explaining his techniques for making these and other Chinese kites; Larry "Ben Franklin" Zilar, who came all the way over from Kennewick and answered questions and explained details about the kite videos (from the J.C. Young and David Checkley collections) every half hour in the Aeroclub Room. In addition to a small honorarium for the WKA, the MOF is going to put on a continental breakfast for the club in one of its meeting rooms on April 1st.

---

## OFFICIAL BUSINESS

### Officers Reports

from DARRYL STEPHISON, WKA President

Welcome the new year in kiting. It's time to celebrate the best of a year gone by and to resolve to make another year even better. And it was a pretty good year, wasn't it? We had our biggest and best Ft. Worden Kitemaker's Conference — the most people, the most classes, the most fun. The Washington State International Kite Festival broke all records again, except for most kites in

the sky, and that wasn't for lack of trying. We had a lot of fun too. Remember trying to fly kites from the top of an 18-story building? Or the back of a tour boat. It was even fun when most of us could not get our fancy kites in the air, but 400 kids with trash bag deltas had a ball in Mukilteo. Picnics at Magnuson Park, Ft. Casey, and Westport bring back memories just as vivid as the big events. Even thoughts of unscheduled, unplanned, almost

by chance meeting of a few members at the Squalicum Marina are enough to make me eager for another year.

How do we top that? Just by being there and doing what each of us likes best. Join us whenever you can. Most of us like people and the more the merrier. Come and bring your favorite kite, your favorite friend, and some chocolate chip cookies and you can't lose. Say "hi" to people you know and people you don't know. Do whatever feels good, as long as it doesn't spoil somebody else's fun. I will be there as often as I can. I will be smiling as long as people smile back. Make a point of saying "hi" to me. One of my New Year's Resolutions is to be a good listener, so tell me what you like and what you don't. I may not solve all of your problems, but if there is a common problem related to kiting, I will make sure it gets consideration by the Board. This organization only exists to serve you, the members. What and how much the organization does depends on your direction and your participation.

Come fly with me and keep smiling!

from Jody Hagaman, WKA Secretary

The January 1st Protest the Bowls and Dave Checkley Memorial Fly was a wonderful success. The reason why? You all were there and the skies were full of lovely kites. We all froze our noses, ears, and toes but we were kept warm inside with hot coffee and the delicious food provided by Dorothea Checkley. A special thank you to Dorothea for all her hard work in making the day a huge success.

Better get your sewing machines oiled and your pens and paper ready for the Ft. Worden Kite Conference is just around the corner. Rumor has it this will be the best one ever. Volunteers are still needed so please contact Llyle Morgan at 206/441-4012. Remember all the fun you had bid-

ding in last year's silent auction? This year's will be even more fun because play money will be given to all volunteers and it can be used as real money in the auction.

I'd also like to encourage everyone to attend the activities of the new Westport Windriders. They feature fun flies and good food and the folks there are wonderful and friendly.

Please be kind and patient with your new secretary, as it takes time to sort through the renewals and get the new membership cards out. If you have sent in your renewal, you will be receiving your new membership card in the next few weeks. If you haven't received yours by March 15, drop me a note or leave a message on my answering machine. Please try to remember that being WKA secretary and being on the Board is a tough job, and try to be kind to the people who are working hard for no pay to make this club run. If you have complaints PLEASE COME TO THE MEETINGS! We also need volunteers. If everyone can just chip in an hour or two here and there, it makes all our jobs that much easier and we can all have more fun. My goal for this year is to encourage more picnics and fun flies. If you would like to share that goal, call me and let's set up some dates and places.

Please check the address label on this issue to see if your dues are overdue. If so, get your renewal in the mail so you will not miss any important information and have to pay the re-entry penalty. And please print clearly. I have trouble reading some of the letters I receive and I hate spelling names wrong.

I would like to thank Past Secretary Al Stringer for all the hard work he did under some unusual circumstances.

See you at the next meeting and on the flying field!

---

## LAST MINUTES

BOARD, January 5

A meeting of the Board was called to order by immediate Past President Tom Sisson at 8:00 p.m. at his home. Also present were Treasurer Bob Hanna, Margaret Holzbauer, Llyle Morgan, Jean Sisson, Darryl and Kathy Stephison. As only two Board members were present, there was no quorum and the business was limited to reports and discussions.

Tom Sisson first reported on an investment offer to the club from the firm of Shearson Lehman & Hutton. As WKA funds so invested would

not be insured and there would be a cost to the club of 8% of the initial investment, the offer was not seriously considered. Bob Hanna offered to look into investing any surplus WKA funds in CD's in our own banking institution. Tom then reported that he and WKA Newsletter Editor David Julian had divided the state into five areas for the purpose of better statewide representation. Shirley Allen has agreed to represent the North District, while Tom Sisson and Gene Smiley have agreed to run for two of the four at-large Board positions. In the hope that many Seattle area members will want to attend the

membership meetings which are to be held on a quarterly basis at each of the other four districts, Tom has investigated the cost of chartering a bus and driver or a large passenger van using our own driver for the trips. Reporting on the Checkley Children's Fund, Tom indicated that the Checkley family wants the money used to teach underprivileged children kitemaking through the public library system. Treasurer Bob Hanna reported that the current balance in the WKA treasury is over \$5000. Bob was also asked to look into the cost of renting a safe deposit box. A donation of books or money to the Seattle Public Library was discussed again. Tom reported that in addition to himself, Duane Davis, Garth Westhoff, and Jack Van Gilder agreed to serve the Seattle area on the telephone committee, while Shirley Allen agreed to serve the North District. Tom also announced that the deadline for the forthcoming newsletter was January 15 and urged anyone with material to be published to have it in the editor's hands by that time. The safety Committee was discussed. Kathy Goodwind will act as chairman, and Don Allen has already agreed to serve. WKA has received an invitation from the Centennial Committee to take part in the "Wings Over Washington" project planned for later this year. The rejuvenation of the WKA Teachers' Packet should start soon. Suzanne Sadow will be working on it, along with Tom Sisson.

Darryl Stephison hopes to find someone willing to do the research necessary to put together a calendar of all scheduled kiting events on the west coast for the entire year so that kiting enthusiasts could plan his activities in advance. Lyle Morgan reported that registration forms have not been sent out yet as plans for the program are not yet firmed up. Tom reminded those present of some upcoming events: Museum of Flight Show, January 21-22; annual kite exhibit at the Science Center for which we will be hanging kites on March 31; Darryl mentioned he would like to get the new Boeing Kite Club involved in the Museum of Flight show. In addition, Tom announced that WKA had been invited by the Canadian Museum of Flight to do a similar show in Vancouver. In order to meet the requirement of the new by-laws that a budget be presented to the membership at the February meeting, Darryl asked that Bob Hanna meet with the other mem-

bers of the budget committee. The new by-laws were reviewed and discussed by those present. A few minor changes and corrections were made, and it was felt that they were ready for presentation to the membership.

It was agreed that the next Board meeting would be at the Sisson home on January 25. The meeting was adjourned at 10:00 p.m.

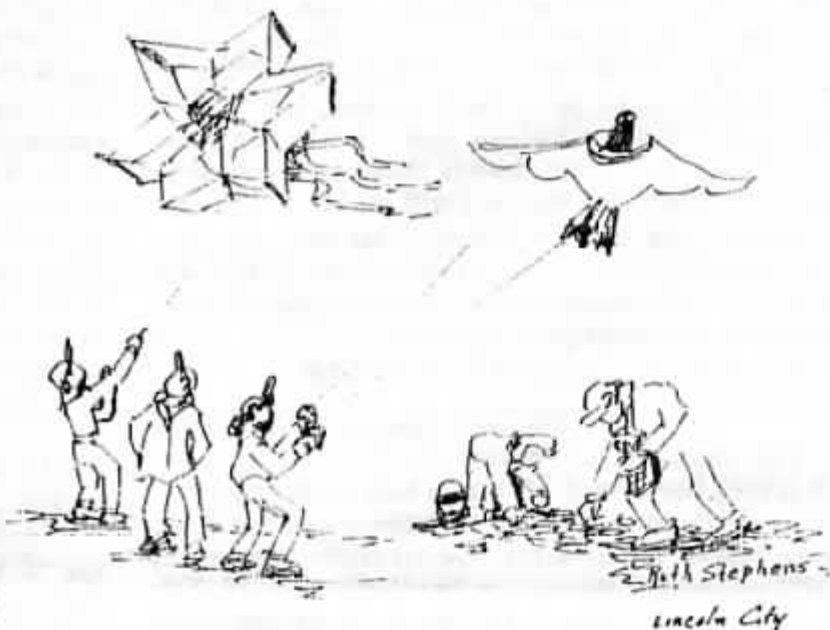

#### MEMBERSHIP, January 14

The meeting was held at the Burger King on the south end of Lake Union in Seattle at 10:20 a.m.

Treasurer Bob Hanna reported that WKA has \$5000 on account. A money market account was discussed in order to make 5% interest on part of the money. A motion was made and passed to acquire a safety deposit box at a cost of \$18 a year. A budget committee meeting will be held at Lyle Morgan's house. Kathy Goodwind, Lyle Morgan, Bob Hanna, Margaret Holzbauer, & Darryl Stephison will attend and draw up this year's budget. David Julian will be instructed to print the new by-laws in the WKA Newsletter. Tom Sisson is chairman of the phone committee. He will be assisted by Garth Westhoff, Jack Van Gilder, Duane Davis, and Shirley Allen. Tom would like to have a few more volunteers. Kathy Goodwind and Dixon Schwenk are putting together a Safety Committee. Part of the committee's goals will be to put out a pamphlet of safety guidelines for manufacturers (to include

with their kites) and for festivals. Kathy will call a meeting on this at Fort Worden. Dan Schwenk volunteered to help with the new WKA Teachers' Packet and he needs other volunteers. Stan Swanson will head a Library Committee, with Sari Moore and Margaret Holzbauer, and they need more volunteers. Tom Sisson is in charge of the Checkley Children's Fund and he reported that the Checkley family has requested that the funds be used for low income areas of the city. It was reported that we now have the four regional members on the Board: North, Shirley Allen; West, Charles Reese; South, Diane Bilotti; East, Marlene Zilar. In compliance with the new by-laws, WKA meetings will be held in different regions so more statewide members can be actively involved. Other meetings will be held at major kite events. Darryl Stephison is working on a calendar which will have all the upcoming kite events. Tom Sisson reminded everyone that April is the month that kites are hung at the Pacific Science Center. Kites and volunteers are needed. Contact Tom Sisson, 206/725-3615. This is an event that brings in funds for the club! Llyle Morgan reported that the Ft. Worden Conference still needs teachers and volunteers. Call her at 206/286-1027. Registration forms will be sent to all WKA members. Donations for the silent auction are needed. If you do any volunteer work for the conference, you will be paid in play money which can be used at the auction. Wings Over Washington will feature kite flies at Magnuson, Long Beach, and Quino Winery. Please limit your lines to 500' on that day as we will be sharing the sky with precision aircraft flyers and we do not want any accidents. Dan and Dixon Schwenk of the North American Powerkite Manlift Team handed out flyers and showed the gear they used for manlift flying.

The meeting adjourned at 12:15 p.m. following door prizes and cake in celebration of our new officers.

#### BOARD, January 25

A meeting of the WKA Board of Trustees was called to order at the home of Tom & Jean Sisson at 7:50 p.m. by WKA President Darryl Stephison. Other Board Members present included Vice President Stan Swanson, Treasurer Bob Hanna, and Trustees Tom Sisson and Gene Smiley. Also present were Margaret Holzbauer, Sari Moore, Jean Sisson, and Jack Van Gilder.

Committee Reports: Treasurer Bob Hanna reported a current balance of \$5,552.99. He will check with Garth Westhoff, Ft. Worden treasurer

to see whether the independent account has been opened. It was decided that all funds in excess of \$1000 should be deposited in a money market account. The Budget Committee's proposed 1989 budget was discussed and accepted. Telephone Committee Chairman Tom Sisson reported that his committee is functioning, but more volunteers are needed. The Safety, Teachers' Packet, and Library Committees have not met yet.

Old Business: The revised version of the by-laws is not yet available. Relating to this subject, Stan Swanson pointed out that the method for choosing at large trustees and regional representatives is not precisely spelled out in the revision. A projected Calendar of Events for 1989 was discussed, and some minor changes were made.

New Business: As there have been no guidelines for handling the complimentary newsletters that WKA receives from other clubs around the world, it was decided that they should be routed first to Jack Van Gilder, Contributing Editor of our newsletter for his review, then to the files kept by Ken Conrad at his shop. Reviewing the event at the Museum of Flight the previous weekend, there was some question as to whether WKA should participate in the future when it was disclosed that no donation would be forthcoming that was beyond the costs of materials for the kite making. Although she could not be present, Ft. Worden Conference Chairman Llyle Morgan forwarded the proposed budget for the 1989 event.

The meeting adjourned at 10:40 p.m.

#### MEMBERSHIP, February 4

The meeting was called to order by President Darryl Stephison at the Burger King at the south end of Lake Union about 10:45 a.m. Due to the hazardous driving conditions, only Darryl & Kathy Stephison, Jack Van Gilder, and David Julian were in attendance. Therefore reading of the minutes, most committee reports, and most of the official agenda were waived.

The budget for 1989 was presented and then less formal discussion was held on a variety of topics, including the new By-Laws, election process for Board Members, status of official WKA pins and patches inventory. Under new business, Darryl introduced a rough draft of guidelines for official WKA sanctioned events, Kathy reported on the AOK Annual Meeting, and Jack Van Gilder reintroduced his ideas for token payments or stipends to certain WKA positions. Upcoming activities were discussed and the meeting was adjourned at 11:00.

---

---

## WELCOME NEW MEMBERS

---

Eric & Susanne Altman, E.  
Wenatchee  
Michael Best, Victoria B.C. Canada  
Eugene Brandli, Kirkland  
Judy Brown, Salem OR  
Bruce Caldwell, Tacoma  
Annie Campbell, Poulsbo  
Roland Campbell, Mountlake  
Terrace  
Cascade Kites, Salem OR  
Frank Conrad, Seattle  
George Cornelius, Yakima  
Koni Dalrymple, Des Moines  
Eric I. Dolph & Lynn, Yakima  
Paul Durant, Calgary Alberta  
Canada  
Mike & Katie Eason, Lake Stevens  
Larry & Janis Flue, Federal Way  
David Gomberg, Salem OR  
Mary Hamilton, Kirkland  
Burke Hinshaw, Enumclaw  
Steven Hoffman, Seattle

Jay Jackson, Des Moines  
Kites 4 Sail, Tacoma  
Kathi Larrabee, Fremont CA  
David Larson, Seattle  
Chuck Lund, Gig Harbor  
Kirby P. MacDonald, Kent  
Jim & Corinne Mansmith, Seattle  
J. David Martin, Seattle  
Melodie Matthes, Seattle  
Joseph R. Mazzuca, Edmonds  
Jim "Red" McClarran, Rockaway  
Beach OR  
Robert & Virginia Meisenburg,  
Tacoma  
William Miller, Lacey  
Don Mock, Boise ID  
Aki & Don Nakashima, Seattle  
John W. Overmier & Geneva,  
Marysville  
Mary Ann Palmer, Everett  
Eric Paulsen, Seattle  
Richard & Leslie Pearsall,

Bainbridge Island  
Ron Pick, Everett  
Bob & Rose Rogers, Brier  
Sally Russell & George, Bellevue  
William & Gayle Schroeder, Everett  
Lerand Shelagh, Victoria B.C.  
Canada  
Scott Skinner, Monument CO  
Jack & Betty Snyder, Bellevue  
John & Barbara Stilson, Camano  
Island  
Bill & Marie Storey, Bush Prairie  
Russ Tankersley & Susan Corey,  
Edmonds  
Stephen A. Tarilton, Seattle  
J. Greg Theriault, Vashon  
John Thomas, Steilacoom  
William & Carol Thompson, Olympia  
David Walker, Bothell  
Morris & Kelci Williams, Woodinville

---

## WKA NEWS NOTES

Barbara O'Neill will be in charge of the Wings Over Washington kitefly July 29 at Magnuson Park. This is part of the official Washington Centennial Celebration. Barbara says she needs volunteers to get started on the project right away. Call her at 206/878-5772

Garth Westhoff is assembling a publication of all the best places to fly kites in the Pacific Northwest. He needs to know the approximate size, location, facilities (restrooms, shelters, etc.), and your comments about your favorite flying fields. Call him at 206/827-1857

---

## REGIONAL REPORTS

---

### BEN FRANKLIN KITE SOCIETY

Most of you have heard of the Ben Franklin Kite Society but may still be wondering how to join and what we do. Well, if you have a BFKS patch, you are a member in good standing and should support safe kiting whenever you fly. We, as members of other parent organizations, wear patches from all over the world. When the public watches us fly and sees our wonderful kites in action, they know and respect us because those patches guarantee organization and safety.

As youngsters in the sport we have all made mistakes and have not always been safe. Please, always remind yourself that others are watching and judging you and your performance. If you are attempting something new, practice in an area that will not endanger others or yourself. You are not only protecting your own image, but the image

from Larry "Ben Franklin" & Marleen Zilar of kites all over the world.

When you wish to dry out your kites and kids, soar to great heights at one of our many wineries, or come to the greatest balloon event in the Pacific Northwest — KEEP UP THE SPIRIT — COME CELEBRATE OUR WASHINGTON STATE CENTENNIAL '89 ON THE EAST SIDE!

For additional information about the BFKS contact Larry & Marleen Zilar (509) 586-2664, John & Linda Zilar (509), or Greg & Margaret Greger (509) 943-3951. To get your BFKS Patch, send a self-addressed stamped envelope and \$3.50 (US\$) to Larry Zilar, BFKS, 1030 W. 14th Ave, Kennewick, WA 99337. [Watch the Kite Calendar for BFKS sponsored events in the Eastern Region — Ed.]

---

## WESTPORT WINDRIDERS

The Westport Windriders are now meeting and featuring a fun fly and potluck dinner at least once each month. They also have a small but first-class monthly newsletter of Western Region kite activities and other information including plans, knots, and events useful for all kites. WW is sponsored by Rich and Jeri Soulier's Pic-A-Patch

Kites and Little Richard's House of Donuts in Westport.

For additional information about the WW contact Chuck Reese, Westport Windriders, P.O. Box 233, South Bend, WA 98586, 206/875-6385 (evenings). [Watch the Kite Calendar for WW sponsored events in the Western Region — Ed.]

---

## SQUALICUM KITEFLIERS

No information was received from the Squalicum Kitefliers as of press time.

For additional information about the SK contact Don & Shirley Allen, Squalicum Kitefliers,

505 W. Bakerview #114, Bellingham, WA 98226. [Watch the Kite Calendar for SK sponsored events in the Northern Region — Ed.]

---

## CLASSIFIED ADS

**OFFICIAL WKA PATCH** — 3" square, green on gold. \$3.50 **OFFICIAL WKA PIN** — green, white, and gold, 5/8" x 7/8". \$2.50 **BUILD SEVEN KITES** and teach others how — official WKA Teaching Pack includes plans for 2 sleds, 2 deltas, eddy, cobra, and delta conyne. \$2.00 to Jody Hagaman, 6739 — 26th Ave NW, Seattle, WA 98117

**ROCKY MOUNTAIN KITEFLIER SEEKS WKA PEN PALS.** I have spent the last 15 years kite flying from the mountaintops and valleys of the Colorado

Rockies. I'd like to share kite flying experiences. Write to Russ Eganbright, P.O. Box 3286, Littleton, CO 80161 (This ad would have only cost Russ \$4.20)

---

**CLASSIFIED ADS** — any items related to kites or kite flyers only 10¢ per word (\$3 minimum) per issue. David Julian, WKA NEWSLETTER Editor, 10254 NE 21st Place, Bellevue WA 98004. (206) 453-8895

---

---

## FROM THE EDITOR'S DESK

Thanks to the Great Ouse Kite Fliers in England for the mention and kind words in their newsletter, *High Lines*. We should all be proud of WKA's international recognition. Special Thanks to all of you who got your information to me before the deadline. If you are going to submit information that is word processed on an IBM-compatible personal computer, please send me a diskette with the data file in either ASCII or your word processor's format. It takes a lot less time for me to import the file than it is to retype several pages of text.

Tom Sisson and I sat down with the membership list, a map of the state, and a pen and we have unabashedly gerrymandered the state into five regions. It seems our plan coincidentally follows the zip code map, so it is pretty logical. The Northern Region includes all the 982xx zip codes greater than 98220 (everything north of Everett that is west of the mountains); the Western Region includes all the 985xx zip codes (Olympia and points west to the coast); the Southern Region includes all 986xx zip codes (Vancouver to the south coast);

and the Eastern Region includes all the zips greater than 988xx (east of the mountains). Temporary volunteer regional board members include Pat Button, Mike Brown, Diane Bilotti, and Marleen Zilar.

It is my understanding that according to the new WKA By-Laws, these regional board positions will be up for elections in the fall along with the executive positions and the new at-large board positions.

Also according to the new By-Laws, the election of officers is going to be by a mail-in ballot. In order to obtain correct information about the number of voting members (as well as to generally update our WKA database), the regional representatives and other telephone committee members will be contacting all the members to verify and update the information we now have on file.

The new WKA Membership Applications are now available. Please do not hand out the old ones any more. Call me at 206/453-8895 and I'll be happy to send you some of the new ones or a master for photocopying your own. WKA Mem-

bership Rosters are also available for the cost of materials and postage. The rosters are for informational purposes only and are strictly **not for commercial use**. The rosters are available in a

variety of formats (print-outs, mailing labels, etc.)

*Deadline for the April issue is March 15.*

---

## SALMAGUNDI, POTPOURRI, ETC.

---

### NEW AMERICAN KITEFLIERS ASSOCIATION TEACHERS' PACKET

After several years of on-again off-again effort, the AKA has finally published its Kites in the Classroom booklet. Although both Jack Van Gilder and Margaret Greger worked on it back in 1984, the final edition is mostly the work of Wayne Hosking. Hosking is a world renowned kiter and author from Australia, via Houston.

The booklet is 32 pages of slick-print (thanks

to Gayla kites), including four very elementary kite plans. Targeted toward the classroom teacher, the booklet features several projects, teaching aids, and general information pages. At only \$1.50 per copy it seems well worth the money. For additional information contact Bob Price, American Kitefliers Association, 2839 Dustin Road, Burtonsville, MD 20866.

---

### BOOK REVIEW: Fickle Fever

Fickle Fever is another in the series of Seattle author Christi Killien's excellent books for and about young people struggling to become young adults in this precarious world. This story is a wholesome but realistic look at an adolescent girl who is looking for something more than a passing fancy and finally finds herself while building and

flying kites at Gas Works Park in Seattle. It includes the plan of Bill Lee's famous Trash Bag Delta Kite from Margaret Greger's Kites For Everyone. [Kathy Goodwind assures me that in spite of Killien's description of her, she has never, ever worn knickers — Ed.]

---

## SUBSCRIBERS TO POPULAR SCIENCE

Look for an ad in the back of the March, April, and May editions of Popular Science concerning the American Kitefliers Association. The ad was

paid for by the Benn Blinn Fund, a \$10,000 honorarium left in his will for the promotion of the AKA.

---

## MORE HOT AIR — OUR READERS TALK BACK

---

from **Dixon Schwenk**, North American Powerkite Manlift Team, Bellevue

In a letter printed in the December WKA NEWSLETTER about the Ft. Casey Kite Fly last summer, Patricia Button refers to "two guys with a stack of Flexis who kept jumping on the support cable from the tower." She continued "that because of these two guys, the park almost canceled the Squaleum Group's Labor Day event."

I would like to answer Mrs. Button by first saying that she certainly had a different idea of what "the two guys with the Flexis" were doing than I did. (I was one of those two guys...) Secondly, her complaint about the harsh response from the park people dramatically disagreed with what Ranger Maribeth Hansen expressed rather glowingly in a letter that was coincidentally printed in the same newsletter right next to Mrs. Button's. Maribeth wrote, "With the exception of one small incident by 'the president', it was a terrific day for all of us here and we hope to have you all back again soon." The spirit of Ranger Hansen's letter contrasted sharply with Mrs. Button's, which continued, "Because of air-headed, egotistical stunt kite flyers, we nearly lost the privilege of flying at Ft.

Casey." Mrs. Button does not qualify this remark. She does not say "a few" or "an" egotistical stunt kite flyer, she makes a mean-spirited character evaluation about what amounts to be a major portion of the WKA membership, based on how many strings they fly a kite with. In the event Mrs. Button is serving as spokesperson for the entire Squaleum Group, her tub thumping has not only failed her constituency, but kite flyers in general. Fueling an already bad situation with superfluous, one-sided remarks about stunt kite flyers certainly doesn't lend itself to a friendly, peaceful remedy. Mrs. Button owes us and this membership an apology.

As one of the "two guys with the Flexis" and as one of the spokesmen for the North American Powerkite Manlift Team, I would like to express the team's concern for any difficulty we may have unknowingly created at Ft. Casey. We are seriously committed to safety, not only for the members of our demonstration team, but also for the folks who stop to watch. We place a premium on courtesy and thoughtfulness in our interactions as a team with the folks we come into contact with. We try to set an example by our actions for others to see and follow. We invite comments and observations from

our fellow kites or anyone else who wishes to contribute to our efforts toward safety and harmony.

from **Charlie Sotich**, Chicagoland Skyliner

Here is my check for my 1989 dues. I want to keep getting the WKA Newsletter for another year. As you might expect, I liked the coverage of the AKA Convention in the December issue. Keep up the good work.

[Thanks Charlie — I know I can count on you to keep me on my toes for another year! — Ed.]

from **Fay & Joe Richey**, Coupville

... The last issue of the WKA Newsletter was very nicely done. I know it helps to hear praise as much as critics, sometimes more so. Otherwise you wonder if it's worth it ... The program is coming along nicely for the Ft. Worden rooms. We're about at the point where we're ready to put it to work...

FROM **Russ Eganbright**, Littleton, Colorado

My name is Russ Eganbright and I have spent the last 15 years kite flying from the mountain tops and valleys of the Colorado Rocky Mountains. I would like to correspond with the members of the Washington Kitefliers Association related to kite making and their flying experiences.

## OUR WKA ADVERTISERS & SPONSORS — TAKE TIME TO THANK THEM FOR THEIR SUPPORT!

Come visit  
our new location  
34th & Wallingford



GASWORKS KITE  
SHOPPE  
3333 Wallingford N.  
Seattle, Washington 633-4780

Kite flying is a true sport of brotherhood so let us all share in this spirit. I would be grateful if my name and address could appear in your newsletter with my request for members to write to me with their kite flying experiences.

[OK WKAer's, here's your chance for a pen pal on the other side of the Rockies! Russ, I'm sending you a complimentary copy of the current WKA Newsletter with a complimentary personal ad in the Classified section, along with a WKA membership application — Ed.]

from **Dwayne Hockett**, East Wenatchee

I am an Eastern Washington kite flying enthusiast and builder. I would appreciate receiving information on the 1989 Fort Worden Conference, as well as other scheduled Washington kiting events for 1989.

[Dwayne, I'm sending you a complimentary copy of the WKA Newsletter, along with an application for membership. Check out the Kite Calendar section — Ed.]



**KITESPORT**  
15600 N.E. 8th Ave.  
Bellevue, WA 98008  
(206) 641-0763  
KITES. WINDSOCKS. TOYS

# Great Winds Kite Shop

Est. 1972

An outstanding collection of kites, kite building supplies, books, accessories, and other flying things . . .

402 Occidental Ave. S. Seattle, Wa. 98104 624-6886

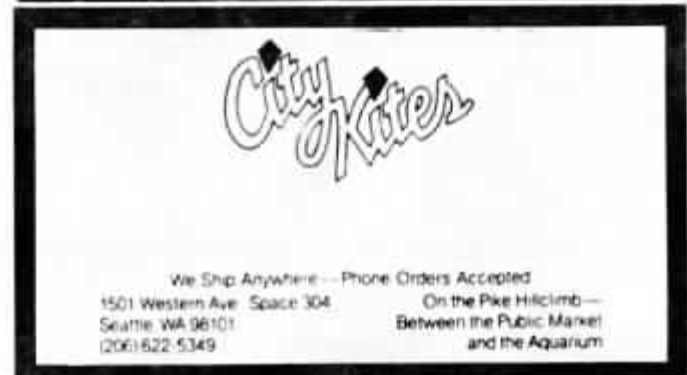

We Ship Anywhere — Phone Orders Accepted  
1501 Western Ave. Space 304  
Seattle, WA 98101  
(206) 622-5349  
On the Pike Hillclimb —  
Between the Public Market  
and the Aquarium

# DELTA KITE -

- "T.L.A.R." construction directions  
(That Looks About Right)

## Materials:

- 1 plastic bag at least 20 x 23 in.
- 2 48" dowels, 1/8th or 3/16th in.
- Strapping tape

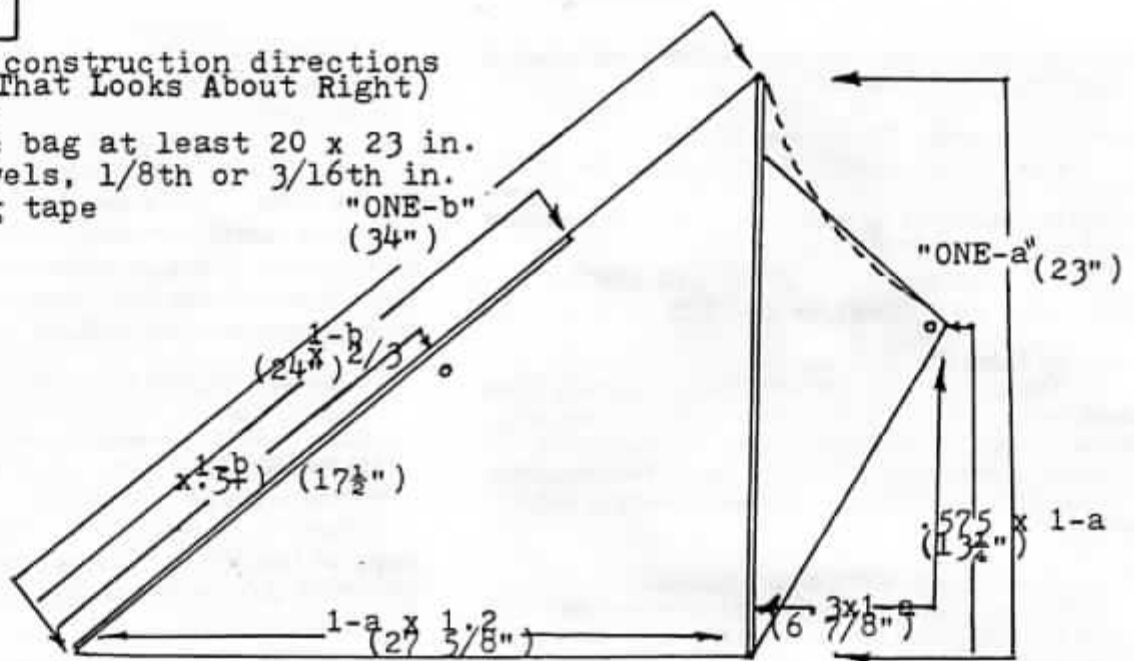

**GENERAL CONSTRUCTION PRINCIPLE:** "Any tape will eventually and inevitably dry up and blow away on a kite." Better: Where possible use heat-bonded plastic, double or triple thickness.

Step (1) - Cut plastic bag, opening up bottom and one side -- spread out.

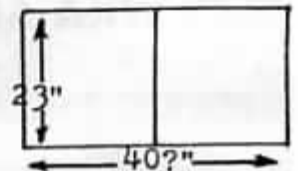

(2) - Using yardstick, keel pattern and ballpoint pen, mark and cut out opened, spread-out bag thusly -----

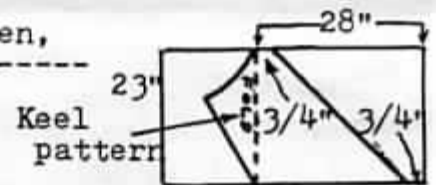

(3) Heat-bond 3/8" pocket into diagonal (leading) edge of each wing. Pocket must be wide enough to accept stick \* -----

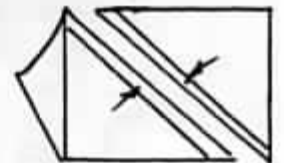

(4) Place one wing exactly on top of other wing and head-bond together along top of keel, with two lines, creating a 3/8" pocket \* -----

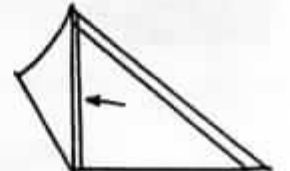

(5) Decorate with heat-bonded applique at this point -- or later.

(6) Cut two sticks 24" long.

(7) Insert 24" sticks into each wing pocket -----

(8) Insert 48" stick into center(spine) pocket; cut to fit --

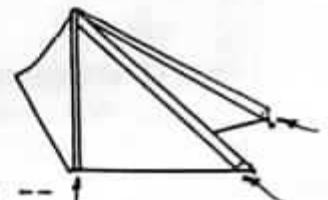

(9) Seal all pocket ends with strapping tape and/or plastic layers, heat-bonded -----

(10) Stiffen and reinforce leading edge of keel with strapping tape or heat-bonded extra layers of plastic.

(11) Cut hole in reinforced keel apex for kiteline attachment -----

(12) Attach fringe to trailing edge of each wing -----

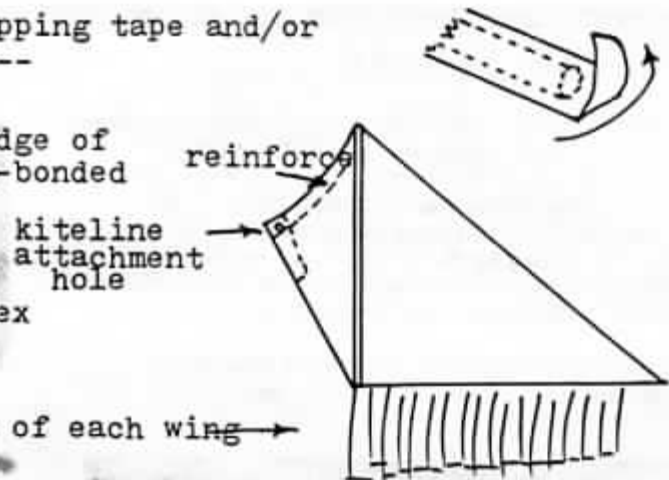

(13) Install "spreader-bar" (stick which keeps wings spread) :

(a) Punch small hole in each wing -----

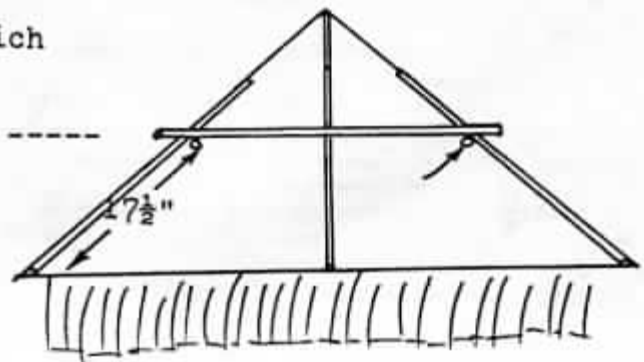

(b) Insert rubber band half-way through hole, -----

(c) - and then through itself, forming a "Larkshead" knot - pull tight -----

(d) Spreader bar should overlap leading edge of wing by about 3/4"; twist rubber band around spreader-bar until medium-tight -----

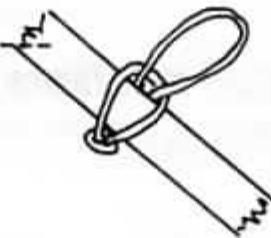

(e) Adjust spreader-bar to form wings in an upsweep -- the more breeze, the more upsweep -----



(14) Go test-fly - !

(15) If kite "yaws" (flies off to one side) cut rudder into keel -----

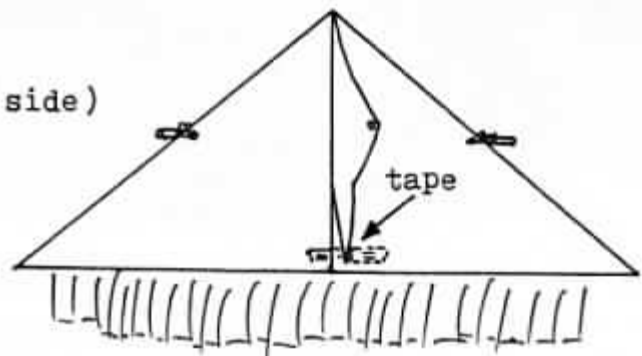

KEN

# KITE CALENDAR

February 11 (Sat), WSIKF Planning Meeting, Long Beach City Hall, noon, Kay Bussing 206/665-5744  
 February 22 (Wed), WKA Board Meeting, Pacific Science Center, Darryl Stephison 206/657-7334 (Days)  
 February 25 (Sat), Westport Windriders Fun Fly and Potluck, all day fun fly at Twin Harbors State Park and 6pm potluck at Kila-Hana Clubhouse, Chuck Reese 206/875-6385 (evenings), a WW event

March 3-4-5 (Fri-Sat-Sun), 6th Annual Kitemaker's Conference, Ft Worden, Lyle Morgan 206/441-4012  
 March 4 (Sat), WKA Membership Meeting, at Ft Worden Kitemaker's Conference

March 18 (Sat), St. Patrick's Eastside Kitefly, Redmond, Marymoor Park near the Velodrome (signs will be posted), Noon, Kitesport 206/641-0763

March 18-19 (Sat-Sun), 2nd Annual Reno International Kite Festival, Reno NV, Competition & prizes, 702/827-7636

March 22 (Wed), WKA Board Meeting, Pacific Science Center, Darryl Stephison 206/657-7334 (Days)

March 25 (Sat), Westport Windriders Kite Group Fun Fly and Potluck, all day fun fly at Twin Harbors State Park and 6pm potluck at Kila-Hana Clubhouse, Chuck Reese 206/875-6385 (evenings)

March 26 (Sun), Kites & Other Delights fun fly, Amazon Park, Eugene OR, Kites & Other Delights 503/344-5483

March 31 (Fr), Hang kites for Pacific Science Center Exhibition (kites will remain up all of April)

April 1 (Sat), WKA Membership Meeting, Museum of Flight (Red Barn, south end of Boeing Field), 10am, includes free Continental breakfast and tour of the museum, contact Darryl Stephison 206/657-7334 (Days)

April 1 (Sat), Eastside April Fools Fun Fly, Redmond, Marymoor Park near the Velodrome (signs will be posted), 2pm or after the Membership Meeting, Kitesport 206/641-0763

April 2 (Sun), 8th Annual Spring Tri-Cities Fly-In, Leslie Groves Park, Richland, Noon, Greg Greger 509/943-3951

April 8-9 (Sat-Sun), "Welcome Spring" Kite Festival, Ocean Shores, single line and stunt kite competition, Ocean Shores Kites 206/289-4103

April 22 (Sat), Westport Windriders Fun Fly and Potluck, all day fun fly at Twin Harbors State Park and 6pm potluck at Kila-Hana Clubhouse, Chuck Reese 206/875-6385 (evenings)

April 29-30 (Sat-Sun), Kiona Vinyards Winery Barrel Tasting and Kitefly, about 12 miles west of Richland just off Hwy 82 (Signs will be posted), Larry Zilar 509/586-2664, a BFKS event

April 29-30 (Sat-Sun), 2nd Annual Surfsand Wayfarer Puffin Kite Festival, Cannon Beach OR, 206/452-4470

## Washington Kitefliers Association

an affiliate of the AMERICAN KITEFLIERS ASSOCIATION  
 PACIFIC SCIENCE CENTER, 200 Second Avenue North, Seattle, WA 98109



**first class**

Morris & Kelci Williams  
 18030 NE 155th Pl  
 Woodinville, WA 98072

Membership Expires: 12-04-89