



Newsletter

July - September 2010

WASHINGTON KITEFLIERS ASSOCIATION

WKA — a nonprofit organization dedicated to helping people know how much fun it is to fly kites!
For the latest news check our website: wka-kiteflyers.org

Editor's Note: I am hoping that by putting this note on the front page more members will send in a try at a fun-filled kite making workshop at Fort Worden, in Port Townsend Washington.

Bob Wendt is sewing on the kite he made in Rob Brasington's class this year at the Fort.
Photo by Georgan Curran



**MAIL YOUR ENTRIES NOW!
POSTCARDS OR NOTES MUST BE
RECEIVED
BY AUGUST 12, 2010 FOR THIS YEAR'S
DRAWING
WKA/Sisson Scholarship
Fort Worden Kitemakers Conference
March 25-26-27, 2011**



Membership dues must be current at the time of the drawing as well as the conference. This scholarship is **non-transferable**. Only SIX entries have been received at this time.

The deadline for entering this year's drawing is almost here!!

Our scholarship program is one of the **benefits of membership** in the Washington Kitefliers Association. We send one member each year to the Fort Worden Kitemakers Conference in Port Townsend, WA. You do not have to purchase a ticket to enter this members-only drawing.

The prize is worth at least \$350.00 which includes conference tuition, conference pin, housing, meals in the dining room, and \$50.00 toward class fees. Limit one entry for each current member that would attend classes.

Mail a note or postcard to: Washington Kitefliers Association, Pacific Science Center, 200 2nd Ave N, Seattle, WA 98109-4816. The drawing will be held at the WKA Lasagna Feed on Wednesday, August 18, 2010 at the hall on Sandridge Road in Long Beach, Washington. You do not need to be present to win.

If you have any questions about this scholarship program, contact the Membership Director, **Sylvia Bernauer** at (425) 822-4605 or dbrn1@earthlink.net.

Visit www.kitemakers.org for more information about the conference. The schedule of teachers with photos of many of the projects will be posted on the site.

Kite Making Brought to Wapato

Kite making was brought to Wapato, Washington, this summer where a group of Mexican teachers had been invited to spend part of their summer vacation teaching Wapato children the customs, legends and heritage of Mexico.

Greg Greger, of *The Ben Franklin Kite Society of the Tri-Cities*, met with student groups and the visiting teachers. They were shown how to build a **Conover Eddy**, "guaranteed to fly" kite from simple, readily available materials. They were then put into teams, helping each other to each make their own kite from supplied materials. Upon completion students were shown how to fast-walk their kites down the building corridor to test their flying capability. When all kites were tested, they moved to a nearby open area to fly their newly crafted kites, also learning flying techniques and safety rules.

It was a successful event.

Wapato is over 65% Hispanic. The visiting teachers taught the children the history, legends and culture of their Mexican ancestry. Most of the students had never flown a kite and this was an opportunity for them to **make** and **fly** their own. The visiting teachers were shown techniques of kite making in the classroom which they could take back to their own classes in Mexican schools. Copies of **Margaret Greger's** book, *Kites for Everyone* were given to the visiting teachers.

Sr. Mary Ellen Robinson, of the **Marie-Rose House**,

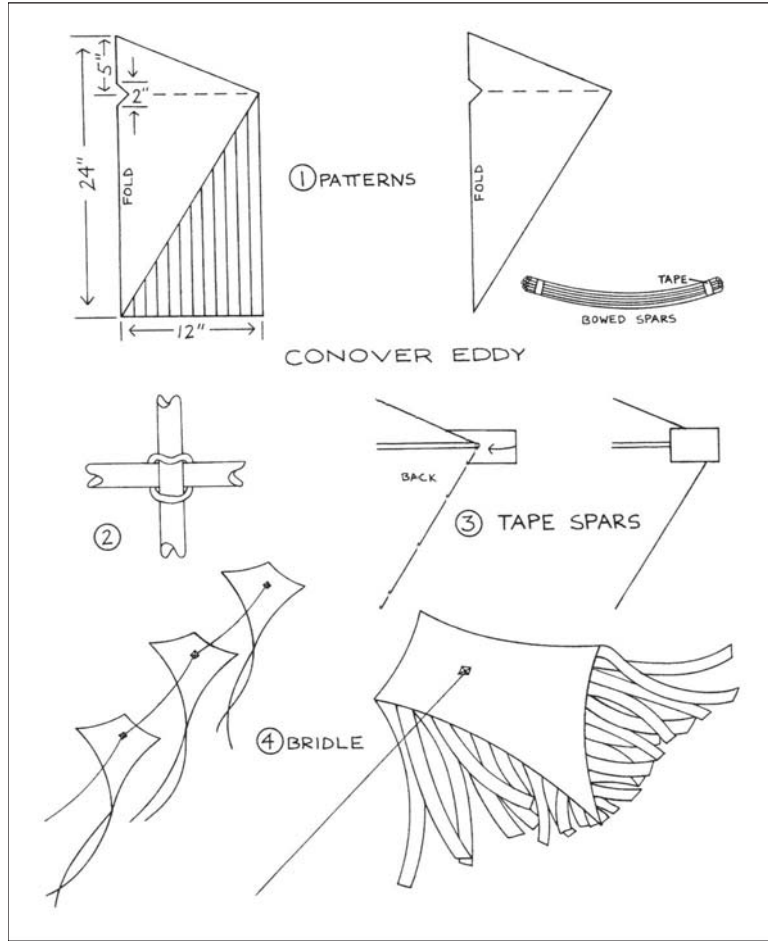

organized the event as part of her "Mexico in Wapato" annual event.

"Greg" Greger

We're Looking for Help at WSIKF

I know that the week at WSKIF can be very hectic, but we need your help with a couple of things.

First on Monday, **Mary Yoshimi** can use some help with **Special Friends Day**. This is an event where people with Special Needs get to come to the beach, see the festival and get to build a kite. If you have never worked with Special Needs, it is an experience you cherish for ever.

We can also use some help with kids kite building on Wednesday and Saturday. This has changed in the last few years. It used to be just a few hours on Wednesday. Now it is all day Wednesday and Saturday. Last year we built over 500 kites and could have done more if we had more help.

Even if you could just give us a few minutes so someone else could take a break that would be great.

Carl Williamson

Museum Workshop Fly for WSIKF

Again this year, on Wednesday, at 1 pm at the **Washington State International Kite Festival**, there will be a mass ascension of kites made at the workshops sponsored by the **World Kite Museum**.

The most prolific workshop presenter has been **John Freeman**. For 14 years, he has held a three-day President's Day Weekend kite extravaganza. These fourteen kites are varied in shapes, sizes, and designs. Bring as many of these to fly as you can to "show off" this incredible man's influence on our region's kites.

However, other presenters and types of kites come in this category of Museum workshop happenings. **Charmayne** and **Bob Umbowers** have had bird and airplane kite workshops; **Brian Champie** gave instructions for the Sentinel Kite. **Deb Cooley, Kathy Goodwind, Gail Lindsay, Heloise Lockman** and others taught appliqué techniques; **Bary Crites** and **Bill Goble** caused cellular creations to hit the skies; early plastic kite adventures from the **Ohashi's** arch, **Greger's** Eddy trains to **Jack Van Gilder's** plastic appliqué creation were made. **Don Mock** and **John Pollock** taught painting on ripstop; **Dan Kurahashi** and **J.R. Tolman's** kites were made and painted on Japanese washi paper; **George Peter's** constructed kites flown in Grenada..... Sorry, I can't get any more of this memorable crowd in a short article.

The **important thing** is to fly as many as possible on the Wednesday, 1 pm, August 18th in field A. The plan is to videotape as much as possible for history, for collectors, etc.

Monday, Tuesday, and Wednesday before and after the fly, sign up with a Museum representative in the Registration Tent so that we have a pretty good record of your participation. A pin is planned See you there.



Congratulations
to
Vic and Linda Eshpeter
for "tying the knot".

WKA Board Members

President: Rick White
Ssragtop@aol.com

Vice President: Ken Conrad
ken@greatwinds.com

Treasurer: Marianne Austin
quillback@clearwire.net

Secretary: Bonnie Ecker
whrlwind@comcast.net

Membership: Sylvia Bernauer
dbrn1@earthlink.net

Education: Ken Conrad
ken@greatwinds.com

Special Events Coordinators:
Glenda Kleppin **Jerry Graham**
gmakleppin@usa.net jlgraham1@usa.net

Safety Chairman: Scott Slater

Products Coordinator: Glenn Austin

Youth Liaison: Kristian Slater

Webmaster: Morrie Williams
mmawilliams@comcast.net

Newsletter Editor: Marzlie Freeman
marzlie@gmail.com



Say Thank You to Kite Merchants

The next time you visit one of the kite stores in our general area, tell them how much you appreciate their generosity of the many donated items that are in the raffles at our festival dinners. There were many kites and other items donated by merchants at the



Westport festival dinner. They added greatly to total drawings, and ticket sales which go toward supporting the festivals.

Suggested by **Sylvia Bernauer**

Ocean Shores Kites "Fun Fly-in 2010" & Hot August Nights Sport Kite Competition

August 14th & 15th 2010 at the Chance A La Mer Beach approach



"Fun Fly in 2010"

For Further Information,

www.oceanshoreskites.com

172 W. Chance A La Mer Blv.

in Shores Mall ~ 360-289-4103

Ocean Shores Kites, Inc. would like to thank:

Sky Dog Kites, Into The Wind, Prism, New Tech Kites, Rubberbandgun.com, HQ Kites USA, James @ Premier, Goodwinds, In The Breeze, Ranger Schmidt with the Washington State Parks, Ken Mercer and the City of Ocean Shores

Over \$3000
in Prizes

Kids Kite
Making

Everyone
Welcome!

Bring
sunglasses,
rain gear and
A smile!



Hot August Nights

Sportkite Competition

Registration forms at www.nwskl.org

or in person at Ocean Shores Kites.

Competition Categories:

- Beginners
- Novice
- Experienced
- Masters

Westport Windriders Annual July Kite Festival

One of the largest kite festivals, which took place July 9-11, 2010, just off the Grayland Beach Road approach with featured guest kite artist **Jose Sainz** of San Diego, CA. In attendance were numerous kite fliers and the amazed on-looking public.

The sky was painted long down the beach with an awesome variety of single line kites, line laundry and dual line kites. Banners waved in the wind with yard art and other forms of wind creations catching the public's attention. AKA sanctioned sport kite competitions were



held and the public again was in awe. The Kid's Kite Making tent was in full swing

teaching and assisting kids in making sleds & flying them.

Saturday's finale was a "more than you can eat" banquet, auction, raffles, awards and pin challenge at the Ocosta Grange Hall. The buffet featured BBQ chicken, glazed ham, scalloped potatoes, baked beans, seasoned green beans, salad, rolls and several desserts for your choice. Lots of fun was had by all. It's an event you won't want to miss next year in July on the 8th, 9th & 10th.

Marianne Austin

Photo of this **Jose Sainz**' kite by **Sylvia Bernauer**

Adventures of a Slightly Crazy Kiteflier

We're out here. Single liners, large kites, stunt kites, kitemakers and we're having kiting adventures! I of course, am just a Kiteflier, but I've created a niche for myself in the kiting world.

- 1) **I've got my credentials.** For a good kite sponsorship, credentials are typically a pre-requisite. Get in competitions and see how you stack up against the best.
- 2) **I give kite lessons.** Patience, patience, patience is utilized here, and even if it sounds like work, it is mostly fun. What could possibly be better than sharing the joy of kite flying?
- 3) **I show kite flying.** I fly demos with just me, or with kids of all ages from the audience. Event organizers love this. The audience loves this and even though I didn't see it coming, I'm wearing costumes and flying my Revolution Kite, which is what it is all about. Ok..and there is untangling kites.. and untangling kites... and untangling kites.

Now, it's a big world out there and I can't stress enough that you too can do this if you play/work at it. Yes, you too can be a slightly crazy Kiteflier.

Where to?

This year, I've been from Mexico to Canada. A few new spots, more invitations than I can accept and plans for new adventures next year. Rockaway Beach had a wonderful kite festival this year, inviting **iQuad**, me and a few other fliers. **Amy Doran** helped **Miriam Shafler** to organize the event, but was away on some secret mission. (In case you didn't hear, that would be our young **Connor Doran**, Amy's son, at the "America's Got Talent" auditions. I sent Connor a card last year telling him to follow his dreams, and by golly he did!)

Morro Bay, CA is the most beautiful spot to fly a kite on the beach and in my favorite parade because it's short and down hill. LOL **You** should fly in Parades!

San Ramon, CA was well attended and I do love flying on a grassy field. The kitefliers in CA over the last 15 years have become like family and we look forward to seeing them every chance we get.

Vanier Park in Vancouver, BC invited me back and it was loads of fun. I think what I enjoy the most is the audience members that return to say hello and help me if they can.

Brookings, OR had so many fabulous kitefliers, it was amazing and you actually had down time between flies. The crowd is the best here and seriously have chairs chained down the night before for the best spots.

By 8:30 AM the whole front row is filled up and we kites have not even arrived to set up yet! Now that's an audience!

Lincoln City, OR If you haven't been to Lincoln City, you really should go! It's a great town and lots of beach. It always has an abundance of big kites and stunt fliers alike.

Georgean took this picture of Penny and her "cast" at Lincoln City (the arrow is pointing to Penny)



Antelope Island, UT will be right after WSIKF. I'm excited about this new event and we get to fly with live bands, **Sawyer Brown** and **Eve 6!**

There are more venues, just too numerous to mention. I'm working on invitations to Borneo, Singapore, or perhaps India. But with a real job, vacation days are limited, so I'll probably only squeeze in one international trip a year. (Not counting Mexico's "Give a Toy, Get a Smile." Kite festival.)

Now, why don't you see me at Washington events? Well, they are competitions, not shows. We need these, but I sure would love to see some kite shows in WA. The audience asks me quite often, when is the show in WA? But, I'm just a Kiteflier, not an organizer, so we are at your mercy. Hopefully, we'll find someone who wants that job in the near future. Meanwhile, I'll be at all the WA events that I can possibly get to, just to support the kitefliers, festivals, meet up with friends and a play day for all our dogs. So if you do not see me at the comp field, feel free to drive down to the end and say hello to me and my kite dog, 2-E. That's where you will find us flying our kites and meeting new people. Hope to see you at the next event.

Best Breezes,

Penny Lingenfelter

Indoor/Outdoor Kiteflier ~who missed as many events as she made it to.

Notes from the Prez



Here we are again, 3 weeks until WSIKF! It's my 23rd year, and I am still as excited to go, as I was my first year. I plan on joining in the Rev fly this year. I hope we can pull off this 100 Rev's thing. It will be grand if we do! And right outside my hotel room! WOW! Life is good. My wife will have a front row seat! I bought a new **Bazzar** custom designed Rev, just for this event! You have it done yet Bazzar? I need that thing right now!

This past season was the busiest and also the most fun I have had ever. We went to the Fathers Day Fly in Magnuson Park. Boy, did it rain. But we did have about 3 hours of good dry flying to dry our kites and banners out. And just as we were packing up, it began to rain again. We got out just in time. I hope the weather doesn't scare anyone off next year. We had a great time chatting and sharing stories, while we were huddled up in my big tent. What are the odds that we would sign up a new member that day! He made the trip from Everett just to meet us. Sylvia had met him up in Tulip Town (Mt. Vernon) and told him about the WKA. And he in turn, looked us up on the web site and found out about the Father's Day Fly there. The WEB is working!

I want to take this opportunity to welcome **Rick Ishida** to our ranks! Hope to see you on the flying field again soon Rick! Side note: He was flying in the rain when we arrived at 9:30 AM. I like this guy!

I would like to take this opportunity to let everyone know we will be collecting ballots this month for the elections of officers. As you will read in this issue, there are two terms up; **Marianne's** (Treasurer) and mine (President). There are several people who could do a great job as

your President. If you run, I promise to vote for you! Please, think about running. We really need someone who can put the time into this job. I am way too busy until I retire. We won't have the results at the dinner, but we should have them shortly after. We will announce them in the next newsletter.

But please, **everyone, VOTE!** You may turn your ballots in to **Bonnie Ecker** at the dinner, or mail them in, sometime in the next 30 days.

The V2 Farm got rained out this year, and that's too bad too, because they had a lot of new things this year. It is at a bad time though. The Fathers day Fly is the very next day. We will be chatting more to everyone, and see if this is something we want to continue, or not.

We also canceled the WKA booth at the International District Summer Fair this year, because of the conflict with the Westport Windriders Festival. **Launny Herriges** and I dropped in on Westport Windriders Saturday, and had a great time chatting with everyone, and flying my new Chess Genki made in **Paul Horner's** class at Fort Worden. We both had commitments on Sunday, so we drove back that evening and missed the banquet. Boo! I really wanted to go eat something!

Well I hope to see everyone at the beach in 2 weeks! (By the time you read this) And remember to send in your donations to the Bag raffle. We could really use those cool kites you have been saving in your attic! Or ready to redecorate your wall with a new kite. Bring the old one to the dinner and donate it to the raffle! We appreciate your help keeping the WKA going. And if you have any suggestions on how you think the WKA should be "Going", PLEASE let us know. Positive change is almost always a good thing!

Have fun out there!

Rick White



WSIKF Lasagna Feed Event

We need volunteers to help at the annual WKA Lasagna Feed on Wednesday August 18. We will be upstairs again this year in the grange hall.

We need helpers with taking in raffle items. It would be a big help if, when

you bring your donations, you bring along paper bags with the donation information already on it. That would really help in getting the raffle items ready.

We always need helpers in the kitchen too.

Quincy WA Kite Festival Report

Be sure to put this festival on your calendar for next year's Memorial Day weekend. They have a great grass flying field. Plenty of room for single lines, stunt kites, and next year a field for kite buggies.

They have a power air foil and fixed wing gathering going on at the same time. Very interesting. The winds were crazy, but where aren't they? We kept up 10 kites most of Saturday and Sunday. Granted, it wasn't all the time, but we got a lot of flying in. Best of all, it was sunny there while it was raining most of the time on the coast.

Georgan Curran

Kite Clubs

Associated Oregon Kiterers

Contact: Deb Cooley
Email: tucoolkites@earthlink.net
PO Box 25616, Portland OR 97298
Membership includes 5 issues per year newsletter

Ben Franklin Kite Society

Contact Larry Zilar
509-627-6751 or email: zilarlm@charter.net

Lavender Winds Kite Club

Brian Bradley
email: KiteBear@aol.com
meet 2nd Sunday, noon in Long Beach, WA

Lilac City Wind Chasers

Contact Bill Cox
509-327-7974 or
email: cxbil@aol.com
Starting in June meet first Sunday of the month in Sky Prairie Park, W. Strong Rd, just east of N Five Mile Rd, Spokane, WA

NW Fighter Kite Association

meets 3rd weekend of every month, location varies.
More info: www.fighterkites.org

Northwest Sport Kite League

Contact Bud Hayes
email: bud@thehayesplace.com Calendar at www.nwskl.org

Peninsula Breeze Blenders

Contact Bill Rogers or Lisa Ryan
email: lisaryan@mail.com or billrogers@earthlink.net
Meets 2nd Wednesday every month, Fire Station, Loxie Egan Blvd.

Pierce County Kiteflyers Assn

President: Bob Wendt
Puyallup, WA 98374, 253-848-6325 (home)
staff@pcka.info Calendar at www.pcka.info (see pg 9)

Squalicum Kite Flyers

Contact Mike Button 360-733-7380 email: kite102@aol.com
Fun fly every Wednesday & Sunday afternoons during daylight savings time until sunset
Zuanich Point Park, Squalicum Harbor. Bellingham WA

Washington Kiteflyers Assn.

Contact: Rick White
email: ssragtop@aol.com
Address on back page of newsletter
Membership includes 5 issues per year newsletter

Westport Windriders

Contact Marla Miller
253-752-7051
email: kyp2@aol.com
meets 4th Saturday every month at Grayland Beach, followed by potluck at Willapa Grange Hall

Whidbey Island Kite Flyers

Contact Allen or Marjorie Taylor
360-678-9358
Meets 3rd Saturday Apr - Oct usually at Fort Casey

American Kiteflyers Association

Contact Theresa Norelius - Regional Director
360-904-1424
email: region10@aka.kite.org Regional: www.aka.kite.org/region10 or www.aka.kite.org

British Columbia Kiteflyers Assn.

PO Box 755
101-1001 W. Broadway
Vancouver, BC Canada V6H 4E4
Membership: \$20 (CDN)
Includes quarterly newsletter
www.bcka.bc.ca



The Newsletter of the **Washington Kiteflyers Association** is published five times yearly. Subscriptions are part of membership in the WKA.

The WKA Mailing Address is:

**Washington Kiteflyers Association
Pacific Science Center
200 2nd Ave N
Seattle, WA 98109-4816**

Editor: Marzlie Freeman
1606 Marine Circle
Parksville, BC V9P1Y7
e-mail address: marzlie@shaw.ca
or
marzlie@gmail.com

Non-solicited articles are always encouraged. Notification is required if contribution is submitted to any other publication. Return of materials must be requested along with a stamped self-addressed envelope.

Advertising rates and information sheets are available upon request.

Accuracy of contents rests with the individual contributor, the WKA Newsletter being held harmless in the event of any error. The views presented in the WKA Newsletter are not necessarily the views of the editor, or the Washington Kiteflyers Association.



Report on Father's Day Weekend Events

There was a busy weekend in June for kite fliers. V2 Farm in Enumclaw which unfortunately got rained into the barn. I heard that a lot of kids did have fun and made kites. But unfortunately there was no outdoor flying.

The following day was Father's Day at Magnuson Park Kite Hill for a little group that dared to come to the hill. It might have been an OK day as it was not raining when I left home. But on arriving, it was sprinkling, and then it was raining.

A few drops did not stop one young man up on the hill flying his sport kite! **Rick White** (our Prez Rick) talked to him and before the day was over, we had another Rick on the membership list. Glad this man enjoyed our group and became a member of WKA. Turns out I had met him at Erv's memorial fly at Tulip Town and passed on the club card and he had looked at the calendar on our site and decided to join us. How nice!

Rick and **Launny Herriges** set up the big tent and swimming fishes and other flying things on poles. And it all displayed well, despite the rain that came down for about 4 hours. We sat all snug and dry inside enjoying snacks and conversations.



The colorful fish got the attention of a local park area resident who was interested in hearing about our big kite festival at Long Beach. Being an artist, he thought he might check into the contest held each year for the festival art poster.

The rain did stop, eventually, and we all ran for kites to fly. There are several photos on the club site of Rick's



mom **Freida** flying her heart kite and Launny and others who got kites into the air. The wind help to dry out the soaked banners and when it started sprinkling again a couple hours later, we quickly hurried to get the tent down and packed away before it got soaked again.

The day turned out well, and as Prez Rick said in a note after the event "I love a happy ending."

Sylvia Bernauer

Sylvia is showing the artist a brochure about the Festival art poster.



Kiting in Alaska

Kiting here in Alaska is something that **Tak Omega**, the president of **AlasKriters**, takes very seriously. He is out year-round no matter what. The top photo was shot in January. The temperature was about 35 below and that



has never stopped him. If there's wind, he's flying.

The bottom photo is flying in July, with the mountains in



the background.

AlasKriters is an AKA Region 10 kite club in Alaska and has monthly meetings year-round.

<http://www.ALASKITERS.com>

See the kite photos from the annual "Kite Day" on July 4th.

Submitted by

Takali Omega

A couple of notes about the Pierce County Kitefliers Association...

The PCKA website has moved. **John Barresi** and **Kitelife.com** host a number of kite related websites. In addition to supporting a kite related business we also cut our annual website expense by 60%. Because of some issues with our domain name we are currently using **www.pcka.info** as our web address. We will get back the old .org address sometime in the future.

We have also changed our meeting location for the summer months. For the months of May, June, July, August and September we will meet at the Chambers Bay Central Meadow. Get there as early as you want to fly kites. Bring your picnic dinner and we will take a few minutes while we are eating to cover any business that is needed. 7:00 PM is still the "official" meeting time. When the days get shorter and colder we will move back to the Summit Library for October, January, February, March and April. Of course, November and December are taken care of by the WKA/PCKA Annual Christmas Party.

Bob Wendt, PCKA President

One Less Kite in the Sky

It is with much sadness the members of the *Lilac City Wind Chasers of Spokane* announce the passing of our past president and current vice president **Bob Murphy**.

Bob and his wife **Bea** built and flew kite trains at WISKF and Pacific Beach for five or six years. He was a good friend and a fine gentleman and we will all miss him.

Bill Cox

**Birds, Birds,
Birds, Birds,
Birds
Coming to the
World Kite
Museum**

The next theme kite exhibit planned for the Kite Museum will be bird kites made in Western Countries. It will make its appearance in September of this year.

Marzlie suggested 'kite plans' as a contribution to the newsletter and a light bulb flashed in our minds.

Helen Bushel, a leader in kite design and education from Australia, has donated to the Museum "Hoo Tee", an owl kite nine feet tall and even wider.

Because Helen is also known for kite making books and kite making plans, we present her plan for a bird kite for "everyman", beginners to advanced.

Have fun creating "Dickie Bird"!

Trefoil

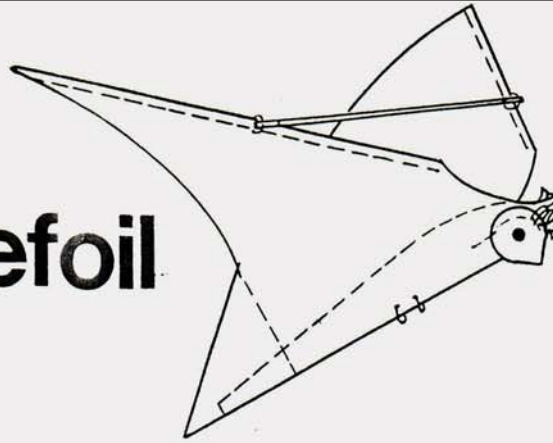

56cm cross bar fixed to rings with rubber band stoppers or plastic sleeves

Bird

DICKIE BIRD

Designed in Ripstop Nylon by Helen Bushell

Partly cut crest

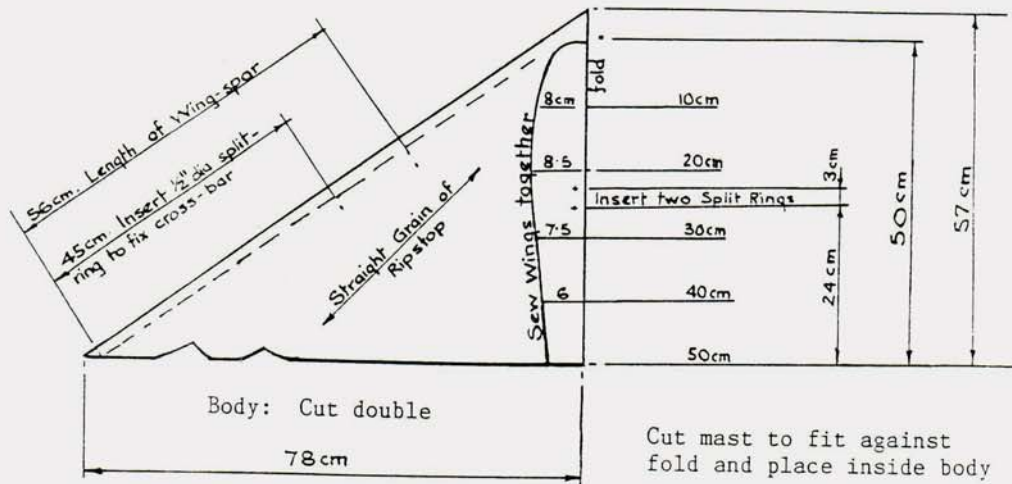

6mm dowel or P.V.C. equivalent for mast and cross bar
4mm dowel for wing spars

Tail: Stitch to wings before the curve is sewn

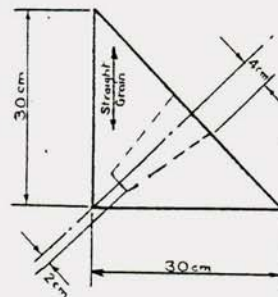

Head: Fold yellow plastic or card and cut 3/4 of a circle 7cm dia.
Machine stitch to head of kite



Plastic tubing with burnt hole to go on split ring as sleeve

14mm black stickers for eyes

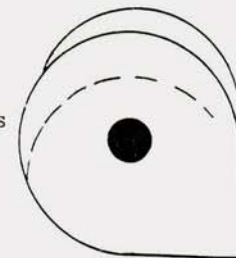

Magnuson Park in July

The **Seattle Family Mentor Kite Festival** is organized by **Gary Boone**. I don't even do demos there. I feel terrible about kicking the kids off the field so I can fly. To me it's a day of sharing my kites with the families. My butterflies, UFO's, a rev on short strings and a few diamonds. It's nice to hear the parents who are so appreciative. One mother told me how bad she felt for her kids who wanted to fly a kite, but she told them they just didn't have one. She was pleasantly surprised to find that my kites were there for their use. The kids fly them, beat them, tangle them and even sometimes **un-tangle** them before handing them back with smiles on their faces. It's always the sunniest day in Seattle for this event and a great place to share kites.

Penny Lingenfelter
Indoor-Outdoor Kiteflier

Courtesy on the Playing (Flying) Field

Just because you have BIG expensive kites doesn't mean you have the right to run others off the flying field by not paying attention or even purposely putting your kites up, thereby knocking other's kites out. Or picking up and moving someone's kites so you can put **your** kite up there. There is plenty of room on the beach for all.

Please be more considerate of others around you.

Georgian Curran

Editor's Note: Having been a recipient of this kind of treatment, I know whereof she speaks.

Important Notice Regarding Parking During Whidbey Island Kite Festival

Whidbey Island Kite Festival will be held on September 25-26, 2010.

Parking adjacent to the field for single-liners will be assigned on a *first-come-first-served* basis which will occur **ONLY** by your email request to:

allen.d.taylor@verizon.net

Phone calls, texts, "howdy-there's" on the kite field, "Don't you remember me from last year", "I always come and want parking" - none of those will be remembered. Not trying to be stinky, just limited brain cells available to process requests.

We thank you for understanding.

Marjorie Taylor

Westport Windriders Kite Festival July 9-11

We had fog and mist this year on Saturday and Sunday, but it was blissfully cool at the beach. As often happens, when it is very hot inland -- it is foggy on the beach. But it really was a wonderful relief to be in cooler temperatures.

There was enough breeze for many of the big kites to fly.

It was great to visit with friends we have not seen for several weeks or months.

Sylvia Bernauer

Barry & Susan Tislow's squids had a good fly.

Photo by **Sylvia**



Kids' Day Update

Please don't forget Kids' Day on Wednesday at WSIKF. We need your kites and your bodies for this event, but will settle for one or the other if you can't do both.

If you can't attend WSIKF and want a Kids' Day pin, just get more than 2 kites to me with a self addressed, stamped envelope, and I will send you a Kids' Day pin. This offer is good for the first 30 people who take me up on it.

If you don't have extra kites to give the kids, we still need your help. First of all, we have many donated kites (thank you **Premier Kites** and **Theresa**

Norelius who talked them into making a generous donation of reduced-price kites) and we'll need a large crew to help put them together before the Foster Grandparent fly. Second, we will need people to take these kites to the field and use them to give flying lessons to kids.

Re Kites: We probably have a sufficient supply of kites to supply kids 7 and under, but still need kites appropriate for older kids. Please dig deep into your kite bags and pull out all those old kites you bought or made but really don't like and/or seldom--if ever--fly. The kids, your kite bags, and the Kids' Day crew will all thank you for your generosity.

Glenda Kleppin

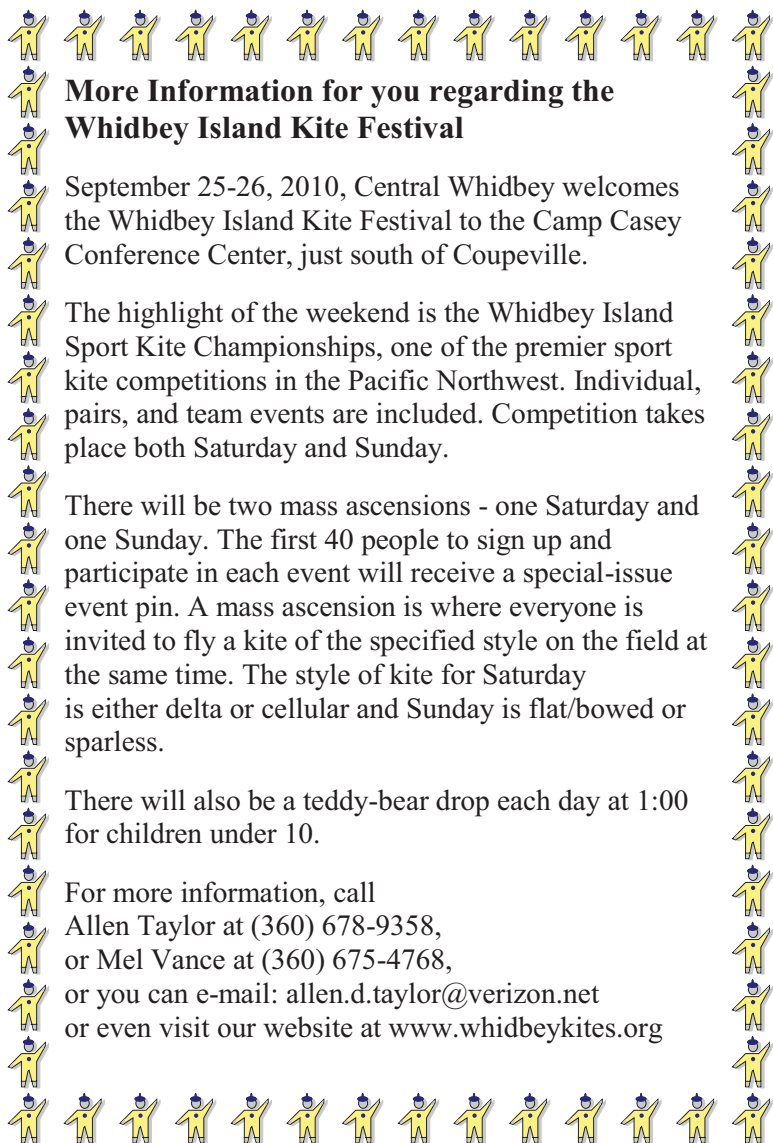

More Information for you regarding the Whidbey Island Kite Festival

September 25-26, 2010, Central Whidbey welcomes the Whidbey Island Kite Festival to the Camp Casey Conference Center, just south of Coupeville.

The highlight of the weekend is the Whidbey Island Sport Kite Championships, one of the premier sport kite competitions in the Pacific Northwest. Individual, pairs, and team events are included. Competition takes place both Saturday and Sunday.

There will be two mass ascensions - one Saturday and one Sunday. The first 40 people to sign up and participate in each event will receive a special-issue event pin. A mass ascension is where everyone is invited to fly a kite of the specified style on the field at the same time. The style of kite for Saturday is either delta or cellular and Sunday is flat/bowed or sparless.

There will also be a teddy-bear drop each day at 1:00 for children under 10.

For more information, call Allen Taylor at (360) 678-9358, or Mel Vance at (360) 675-4768, or you can e-mail: allen.d.taylor@verizon.net or even visit our website at www.whidbeykites.org

Seaside Oregon 2010 AKA Convention October 11-16, 2010

Are You Ready to Have Fun??

Host Hotel and Convention Headquarters:
Shilo Inns Suites Hotel,
30 N. Prom, Seaside, OR 97138
1-503-738-9571

Host Facility for all AKA Convention Programs:

Seaside Civic & Convention Center ,
415 First Ave , Seaside, OR 97138

Host location for all outdoor AKA Flying Events:

Oregon Beaches, State Parks
All Flying will be on the beach in front of the Shilo Inn Suites Hotel

The flying fields, host hotel and convention center are all within three blocks of one another.

Don't forget this year AKA National Convention is again in our back yard this October. Make your reservations early to get a discount.

For those of you who are planning to make things for the AKA raffle and auction, **Jerry** and I still have kite fabric left over from the convention 4 years ago and you can get other colors from **Deb Cooley**. Just let us know what you need. Let us know before WSIKF so we can get it to you during that week if you are going to be there.

Glenda Kleppin

PARADISE FOR TETHERED AVIATION

So, the **Parksville Kite Festival** has come again, and gone again, and you missed it again, didn't you. Well, I wouldn't want to make you feel bad, (right!) but here is what you missed: flawless weather, nothing but blue skies, temperatures in the low seventies, silky smooth breezes off the water, nice clean grass to fly on, fly what you want, when you want, coffee and donuts on the field for the fliers, Saturday night dinner with a drink of your choice, your car parked three feet from where you are flying—no hauling stuff for what feels like miles—whew—have I missed anything? Sunday was a very good day for flying, but Saturday—ah, Saturday—the kind of day kites dream about, and get about once every five years or so. Totally smooth wind, about six or eight mph, coming in right off the open water. The kind of day when you could fly, and we did, lots of stuff close together with no problems.

You have probably heard me mention this before, but this is a festival for kites. The Parksville Lions Club does all the work, and we have all the fun. And while we are having fun, the public is out there enjoying our displays. One lady told me what a treat it was to be able to see the kites from underneath, so the art is all visible, rather than from way off to one side where you see pretty much nothing but the edge of the kite.

This year, besides us common folk flying kites, we had magical displays by **Carl Bragiell**, the one man kite team, and from **Island Quad**. Those kites out there who



don't have any kites yet ate it up!

Oh sure, I know this is a little out of your way up here. There is that bit of driving, and now and then a lineup at the border, and you do have to tolerate a couple of hours of riding on one of our first class big ferries with the world's biggest ferry fleet through the sparkling waters of the Salish Sea, but hey—you can do it! Kites are tough, I know you can do it.

Next year, same time, same place, the weekend after Westport Windriders Festival.

See you then—if we are both lucky!

John Freeman
marzlie@shaw.ca

Editor's Note:

I got these pix off Carl's Facebook photo page. The picture here is taken from the ferry when it's almost in to Duke Point. Great spot.

World Kite Museum News and Happenings

Saturday, September 25th Smithsonian Magazine Museum Day

The Smithsonian provides free admission passes to participating museums on this day. The World Kite Museum has participated since the inception of this event.

Passes are available in the monthly magazine and can be printed off the Smithsonian web page at the beginning of September. Watch for Kite Museum specials on that day.

Saturday & Sunday October 9 & 10 One Sky, One World – Long Beach, WA

Sunday October 10

A Rob Brasington Kite Train Workshop

Check www.worldkitemuseum.com to see how to sign up for this one-of-a-kind kite making experience.

Come a day or two early for the AKA Convention
Take home something special.

Bob Milne Concert

Mark Your Calendars

Sunday, November 14, 2010, 2 pm

Call to reserve your tickets

360-642-4020

Piano wizard Bob Milne again brings his rhythm packed boogie-woogie jazz to support the World Kite Museum.



Under the Big Top WSIKF

Don't miss the Awards Banquet and Museum Auction Fund Raiser. Bag Raffle, Silent Auction and entertaining Loud Auction with items made especially for this event. They include kite memorabilia and kites ranging from old favorites, artistically designed creations, and some brand new kites from manufacturers.

We also need your donations for the auction. Please bring your donations to the Museum ahead of time so that we can process them and be sure everyone gets credit.

Don't forget it's an evening of sharing memories, meeting new and old friends, and laughing lots.

See you there. August 21, 2010

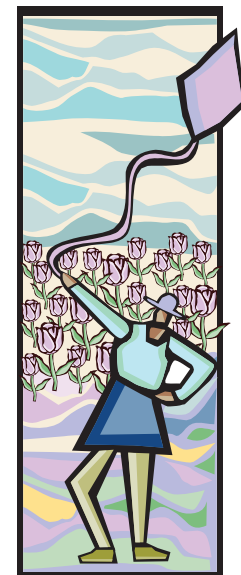

*Editor's Note:
whoever it is that
did this kite flier
clipart must have
seen the kite flying
that happens in the
tulip fields of
Washington. Pretty
cool!!*

Washington Kitefliers Association

An affiliate of the American Kitefliers Association

Join the WKA & share the fun! Benefits include our quarterly newsletter, a membership card which entitles you to a 10% discount on kite related items at participating kite stores, entry to members-only drawing for a scholarship to the annual 3-day Fort Worden Kitemakers Conference, & information about special events in the Northwest kiting community. Membership per household in U.S. is \$15.00/year, outside U.S. \$20.00/year. Fill out application, return it with a check or money order payable in US funds to WKA.

MEMBERSHIP APPLICATION

Mail to:

Washington Kitefliers Assn
Membership Director
Pacific Science Center
200 2nd Ave N
Seattle WA 98109-4816

Name _____ Spouse _____

Address _____

City/State/Zip _____

Visit us on the Web at
<http://wka-kitefliers.org>

Phone _____ E-Mail _____

Names of Other Household Members (Include different last names):

Calendar of Events — *For more calendar information: <http://wka-kitefliers.org>*

- Aug 14-15 Hot August Nights Ocean Shore Fun Fly and Sport Kite Competition
See page 4 for particulars
- Aug 16-21 Washington State International Kite Festival (WSIKF) Long Beach, WA
- Sep 11-12 Up Your Wind Kite Festival Pacific Beach WA
- Sep 25-26 Whidbey Island WA Kite Festival
see info on page 11
- Oct 11-16 AKA Convention
Seaside, Oregon—see page 12

2011

March 24-27 Fort Worden Kitemakers Conference,
Port Townsend WA www.kitemakers.org

Please drop us a line if you have events that need adding to the calendar. Then we all will be in the know!

Editor's Notes—

You know what? I thought we would have had more input from you members for the newsletter. But we still have 16 pages, so I guess that is ok.

Next up is WSIKF. Are you all looking forward to the fun and games of that week of kiting fun? And all the food you can try and all the stuff you can buy from the vendors on Bolstad,? (and the stores in Long Beach too) Then there is the WKA Lasagna feed on Wednesday night, followed by the AOK burgers and hot dog bash on Thursday night. Hum, I must be hungry!! Cuz I know there is kite flying too.

*We will be putting out one more newsletter this year before December. So save up pictures and words for that newsletter, cuz I will be writing and asking for input from you. Come On—I know you can do it—really!!
Good flying,
Marzlie*



New Member Report

Allen Chambers & Linda Manius Belfair
Ben Dantonio Spring Valley, CA
Richard "Rick" & Denise Ishida Mill Creek
Ed Paulsen Vancouver

Welcome to our kiting family.
<http://wka-kitefliers.org>

WASHINGTON KITEFLIERS ASSOCIATION
Affiliate of the American Kitefliers Association
PACIFIC SCIENCE CENTER
200 2ND AVE N
SEATTLE WA 98109-4816



Printed Material Newsletter

The last page photo——
Your Editor working on a **Brasington** class kite at Fort Worden.

Photo by **Georgan Curran**



**More Than Your Average
Kite Store**

*Single, Dual & Quadline Kites
for all Skill Levels. Repairs,
Parts, Excellent Lessons,
Flying Toys, Rubberband Guns.*



*Andy, Brenda & Tom
360-289-4103
P.O. Box 181
172 W. Chance A La Mer
Ocean Shores, WA 98569
www.oceanshoreskites.com*